

# CARVER

## INSTALLATION AND SERVICING INSTRUCTIONS

FOR THE  
1800 S CARAVAN HEATER



### **LEAVE THESE INSTRUCTIONS WITH THE APPLIANCE**

**WARNING** THIS HEATER MUST BE INSTALLED AND SERVICED BY A COMPETENT GAS FITTER WORKING TO THE GAS SAFETY (INSTALLATION AND USE) REGULATIONS 1990, THE HEALTH AND SAFETY AT WORK ACT AND THESE FITTING INSTRUCTIONS.

## 1. WARNINGS AND INFORMATION

- 1.1 The heater is suitable for installation into caravans complying with B.S. 4626.
- 1.2 As this heater is underfloor flued any ventilation hole in the same floor channel or within 1 metre of the flue **MUST** be blocked off and relocated outside this area if necessary.
- 1.3 Where children, the elderly or the infirm are present we recommend that when in use a guard be fitted around the heater.
- 1.4 There must not be a mantelpiece or shelving sited above the heater.
- 1.5 Curtains **MUST NOT** hang within 150mm of the sides of the heater or within 300mm above the top of the outlet grille.
- 1.6 Adjacent furniture or upholstery must be clear of the heater case by at least 5 millimetres.
- 1.7 The Carver 1800 S heater is approved to the relevant sections of B.S. 5258 part 13 1986 under the National Measurement Accreditation Service (NAMAS) and is manufactured to the quality standard of B.S. 5750 part 2./ISO 9002 1987.
- 1.8 The data badge is located on the metal plate adjacent to the valve/ignition control rod.
- 1.9 Aerosols and highly flammable materials **MUST NOT** be stored in compartments behind of adjacent to the heater.
- 1.10 This heater does not contain asbestos or any asbestos related products.
- 1.11 The gas supply to the heater must be from a regulator of adequate capacity giving a working pressure of 28 mbar Butane or 37 mbar Propane. Under NO circumstances should an industrial or adjustable regulator be used on caravan applications.
- 1.12 The heater **MUST NOT** be operated while refuelling or when the vehicle is in a confined space such as a garage.

## 2. THE HEATER KIT

The Heater kit consists of the following:-

- 2.1 1 Box containing:-
  - 1 Heat Exchanger Assembly
  - 1 Case
  - 3 Screws No. 8 x 30mm long (Brown)
  - 5 Screws No. 8 x 20mm long (Silver)
  - 6 Woodscrews No. 6 x 12mm long (Silver)
  - 1 Control rod/Piezo assembly.
  - 1 Floorplate clampstrip
  - 1 Set of literature in polythene bag
  - 1 Floor cutting template
  - 1 Control knob bezel
  - 1 Blanking bezel
  - 1 Name badge
  - 1 Installation box outer section
  - 1 Installation box inner section

### 3. CHOOSING THE POSITION FOR THE HEATER

The heater is normally fitted into the panel below the wardrobe door. Before commencing any fitting ensure that the appliance will fit into the desired position (see fig 1). The installation box will be recessed into the panel by 110mm.

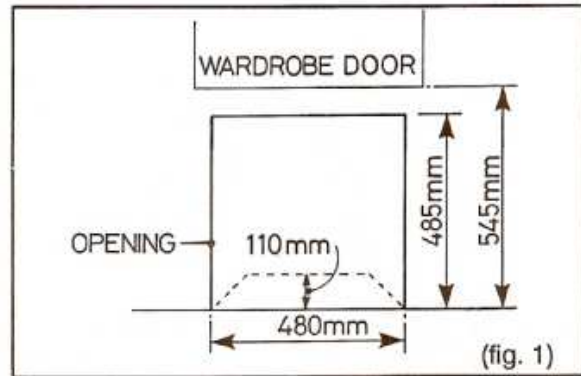

### 4. FITTING THE HEATER

4:1 TURN OFF the gas supply at the cylinder.

4:2 If possible lift away the floor covering from the front of the panel or wall into which the heater is to be fitted. If this is not possible the template will have to be positioned on top of the floor covering.

4:3 Fold the template provided in the pack upwards along the arrows marked 'installation box front face RH Heater' and place in position as shown in fig. 2 with the rectangular cutout to the right. Mark and drill two small holes at the front corners (A & D on the template). Drop a nail or similar through the two holes and check below the caravan that the area between the nails is free of obstruction.

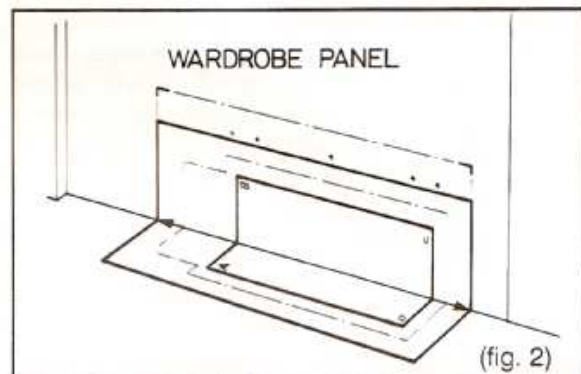

4:4 If any obstruction is found then refold the template along the arrows marked 'Installation box front face LH Heater' and place in position with the rectangular cut out to the left. Mark and drill two small holes at the front corners (B & C on template). Drop a nail or similar through the two holes and check below the caravan that the area between the nails is free of obstruction.

4:5 If an obstruction is still evident, the heater must be repositioned in another area in the vehicle.

4:6 When satisfactory, mark the hole to take the installation box. This will require a hole to be cut in the panel 485mm high (from the floor, below carpet level) x 480mm wide. It is recommended that the panel surface is protected by masking tape. Score the line to be cut with sharp knife, to stop the veneer lifting (see fig 3) If the panel is of the hollow type, then the void must be filled locally along the opening with wood.

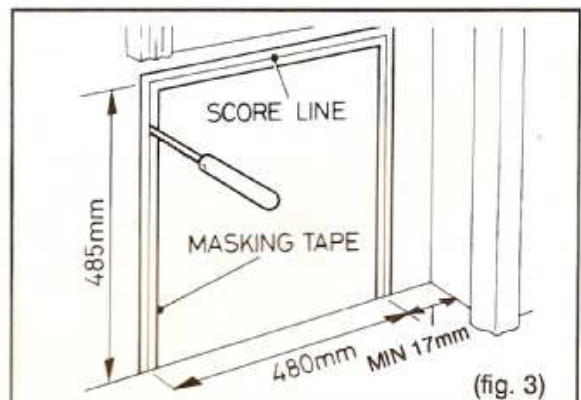

- 4:6 Trim the floor covering from inside the wardrobe or panel to a depth of 135mm from the front (see fig 4). If the floor covering is not wanted behind the installation box remove as required. Also trim the floor covering in front of the panel to the lines on the template.

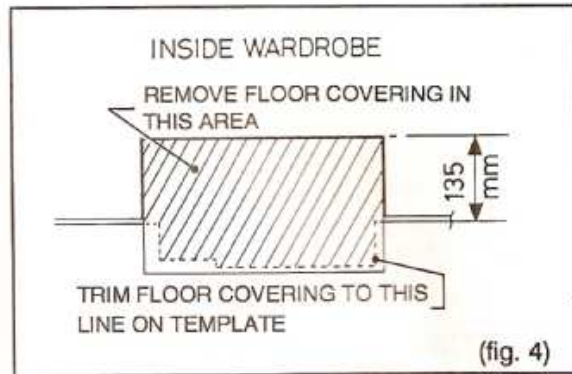

- 4:7 Open out the template making sure that the arrows remain in their relative positions. Mark and cut the floor hole at A,B,C, & D. on the template (See Fig 5). Remove some of the insulation and insert timber liners for added security of the fixing screws, and to seal off the caravan floor insulation. The liners must be secured to the floor using suitable adhesive or screws and their size must be such that all holes marked on the template fall within the inserts. Do not insert screws where they will contact the floorplate cork gasket of the heater.

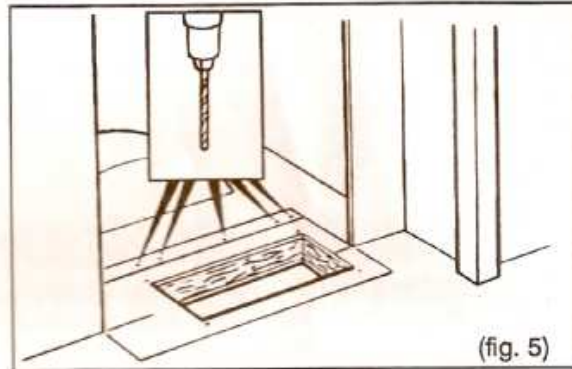

- 4:8 Drill five 2mm dia. holes, as marked on and to the rear of the template. (See fig. 5).

- 4:9 Line up the floorplate clampstrip with the five pre-drilled holes, ensuring that the overhung edge is facing forward. Secure with 20mm screws provided. Tighten down the two outer screws firmly (see fig 6) leave the three inner screws loosely driven at this stage.

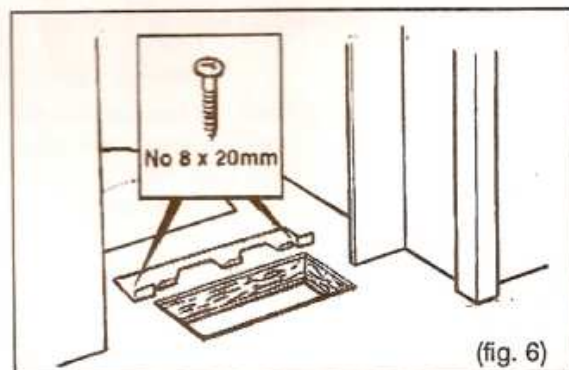

#### 4:10 Assembly of the installation Box.

Locate the inner box on the rear tabs (see fig.7) Fit the top brackets of the inner box through the slots in the outer box top flange (See fig. 8)

Under no circumstances must the heater be installed without both inner and outer installation boxes being fitted correctly as this will cause damage to the heater and surrounding cabinets and may invalidate the warranty.

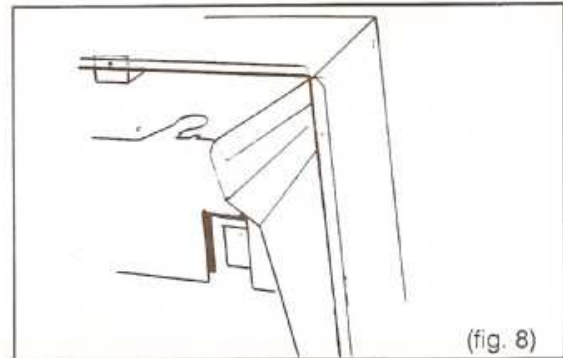
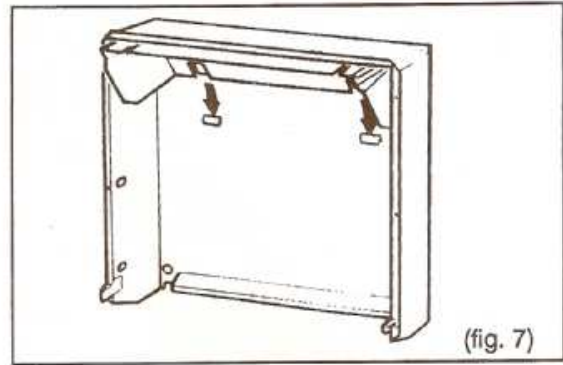

4:11 Position the installation box into the opening ensuring that the bottom edge of the box is on the floor. Secure the box to the panel with the six woodscrews provided (see fig 9).

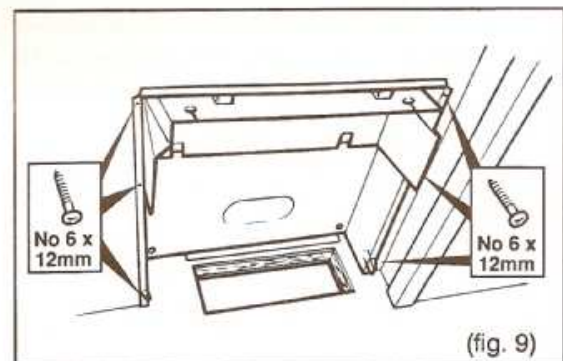

4:12 Lower the heater into the floor hole and position the heater centrally in the installation box, ensure that the rear edge of the floorplate is pushed under the floorplate clampstrip. (see fig. 10 point 1).

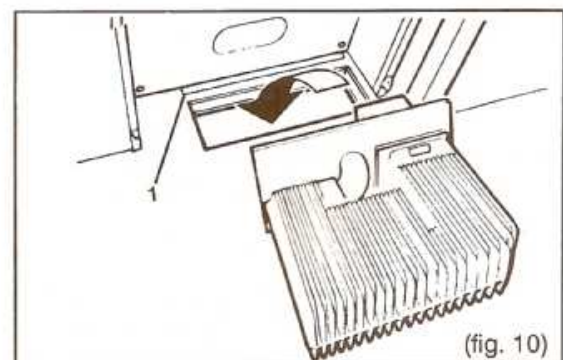

- 4:13 Once the heater is in position secure with the three brown screws provided through the holes in the front edge of the floorplate (see fig 11). Drill 2 millimetre pilot holes if screwing into solid wood.
- 4:14 Working inside the wardrobe tighten the remaining three 20mm screws to the floorplate clampstrip.
- 4:15 It is important that all the screws are tightened evenly to avoid distortion of the heat exchanger floorplate, and to ensure an air tight seal to the floor.
- 4:16 **IMPORTANT:** The floorplate **MUST NOT** be positioned on top of the carpet, or other floor covering, as an air tight Room Seal cannot be attained in this manner.

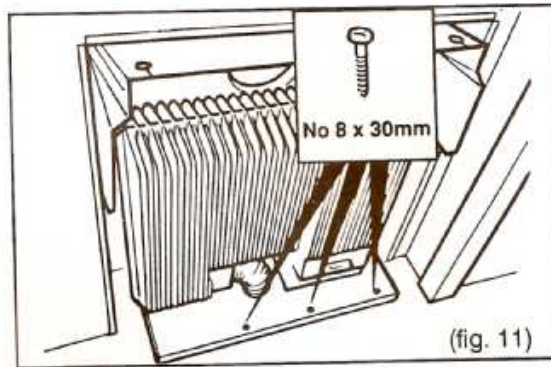

## 5. CONNECTION TO THE GAS SUPPLY

Ensure that the gas supply is turned OFF at the cylinder.

Connect the 8mm diameter caravan heater feed pipe to the gas valve under the caravan, using the nut and olive provided. In tightening the valve connection, two spanners **MUST** be used: one to tighten the nut and the other on the flat surfaces of the valve itself.

**Do not** put the gas pipes or valve under any strain during fitting.

**NOTE:** The size of the supply pipe **MUST NOT** be less than 6mm (1/4") O.D. An approved isolating valve, mounted in an accessible position is recommended. After connecting up the heater, turn on the gas at the cylinder and check the system up to the appliance, including the gas valve, for leaks using soapy water, or other approved methods.

## 6. FINAL ASSEMBLY

6.1 First fit the control rod/piezo assembly: Locate the piezo igniter ball joint over the shaped gas control rod extension, and push securely together: (fig 12).

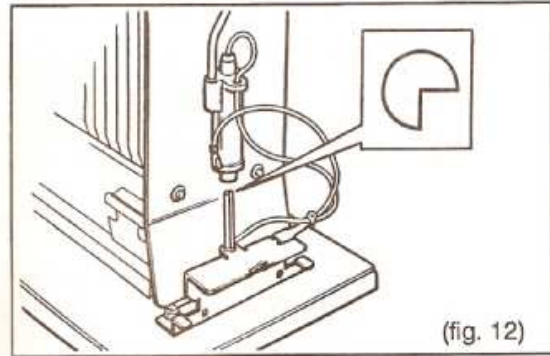

6.2 Connect the free end of the earth lead onto the tab on the side of the piezo igniter housing. Firmly push the small insulated female connector on the igniter lead through the guide hole and onto the male terminal on the igniter unit. (see fig 12)

6.3 To fit the bezel and blanking plate, locate the plastic moulding in the correct aperture and "snap" into position by firmly pressing down (fig 13)

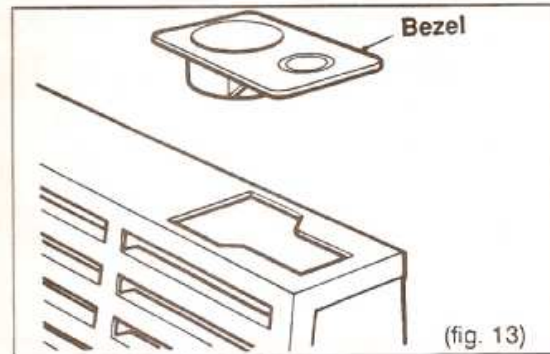

Right hand heater: Fit the control knob bezel into the right hand aperture on the top of the case and the blanking plate to the left hand side.

Left hand heater: Fit the control knob bezel to the left and the blanking plate to the right.

6.4 Fit the name badge.... Locate the name badge in the correct front case aperture viewing window and snap into position. For a right hand heater the name badge is fitted on the left hand side and for the left hand heater the badge is fitted on the right hand side.

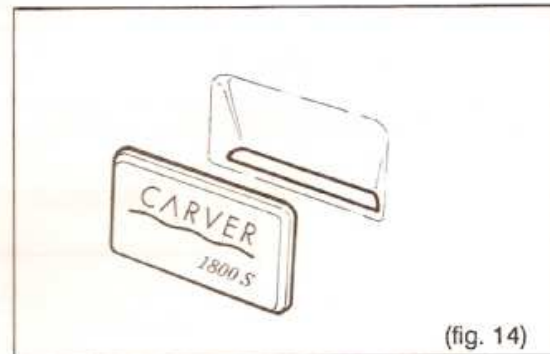

6.5 Locate the heater case over the top edge of the installation box and the control knob. Press in the bottom of the case onto the spring clips located at the bottom of the installation box. (see fig 15). It will be useful, at this stage, to check the piezo operation, by pressing the control knob rod assembly firmly downwards several times and observing the spark at the burner, on each operation. If a spark is not present, check assembly procedure in sections 6.1 and 6.2 above.

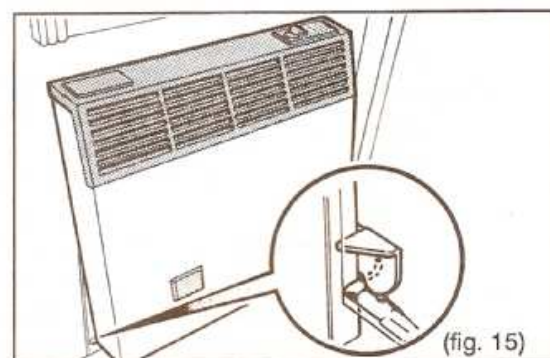

## 7 TESTING THE HEATER

1. Purge any air from the system by turning the control knob fully anti-clockwise and firmly holding it down, for approximately 20 seconds.
2. Turn the control knob fully clockwise and release.
3. **WAIT 3 MINUTES TO CLEAR ANY RESIDUAL GAS.**
4. Turn the control knob fully anti-clockwise to the "↗" position and then press firmly downwards. A click will be heard as the igniter operates to light the burner.
5. Continue holding the gas control knob down whilst checking that the burner is alight by observation through the viewing window. It may require several operations of the igniter to light the burner.
6. Continue to hold the control knob down for 30 seconds then release the control knob and the burner should remain alight.
7. If the burner does not remain alight wait 3 minutes and repeat operation from 4.
8. To turn off the heater return the control knob to '●' position.

## 9. TECHNICAL SPECIFICATION

HEAT INPUT	MAX. MIN.	1.86 kW 0.8 kW	
HEAT OUTPUT	MAX	1.60 kW	
GAS CONSUMPTION	BUTANE	MAX MIN	136 g/h 58.5 g/h
	PROPANE	MAX MIN	134 g/h 57.6 g/h
EFFICIENCY MAX.	GROSS	85.9 %	
GAS SUPPLY PRESSURE	BUTANE PROPANE	28 mbar 37 mbar	
GAS FEED PIPE TO HEATER		8mm O/D	
MINIMUM SUPPLY PIPE SIZE		6mm O/D	
IGNITION		PIEZO	
WEIGHT		10.9 kg	
CARAVAN SIZE RECOMMENDATIONS (UK)		5 metres (16ft.6in.) March to October 4.4 metres (14ft. 6in.) All Year	



## SERVICING INSTRUCTIONS

The Gas Safety and Use Regulations 1990 and various British Standards lay down strict requirements for the installation and servicing of LPG appliances installed in domestic premises and mobile homes, such as caravans or motor vans. Carvers operate special training schemes for Dealers and their staff to ensure that they understand these legal and technical requirements when working on Carver LPG appliances. This facility is backed up by an on-call system operating from Carver's HQ at 0543 452127.

The installer of the LPG appliance, be it at the Caravan Manufacturer's factory or at the Dealer's site or on the Caravan site itself, carries the first responsibility of correct installation according to Regulations and these Carver Instructions but this responsibility is carried forward to any service engineer who is required to service or repair the appliance.

If therefore, you are called to a site to service or repair the LPG heater you must ensure that there have been no adverse changes of installation or use since the time of first installation and complying with Regulations applies just as importantly even if the service engineer's operation is only disconnecting and re-connecting the appliance for attention off the site.

These requirements understandably are directed at the SAFE and EFFICIENT use of the heater. There are no short cuts to safety and you are reminded that you must be properly trained before you work on LPG appliances.

The Carver 1800 S is a reliable well tried appliance and should give years of satisfactory and trouble free use but like all gas appliances, it needs servicing on a routine schedule. The following schedule covers work on the appliance, both in the caravan and when removed from the caravan for attention in the workshop. These are the main headings of the schedule but other work may be required depending on the circumstances at the time of dealing with the heater.

### (i) When serviced in the caravan itself and normally working

- (1) Check the appliance is being used correctly, i.e. there are no fire risks through proximity to shelves and clothing;
- (2) Check the air inlet and flue outlet are not blocked and in the correct position on the van;
- (3) Check the systems for gas tightness;
- (4) Check that it has been installed correctly. Refer to these Instructions to the Installer especially on proper clearances around the heater;
- (5) Check that the gas supply system is correctly installed and working;
- (6) Check that there are no dangerous hot spots on the heater when in operation; indicated by burnt areas of decorative paintwork;
- (7) Check that the controls operate smoothly and correctly and that the flame failure system works satisfactorily;
- (8) Check the flame structure on the burner itself and see that the ignition system works satisfactorily;
- (9) Now remove the case from the heater, replace any faulty components, clean away all extraneous dust, check the operation of all components and safety devices;
- (10) Check the gas tightness of the installation at the end of the servicing schedule;
- (11) Confirm that the user understands the operation of the heater./

### (ii) When the appliance is serviced away from the caravan

Servicing the appliance itself in a separate workshop will require, where appropriate, attention to items 2-10 above.

### (iii) Fault diagnosis

When called in just to diagnose and repair any working fault, even a simple correction will still require you to carry out the standard servicing schedule in case one detectable fault has cloaked other potential faults.

We have included here a fault diagnostic chart to help you to trace faults in the ignition system.

# FAULT FINDING

Turn the control knob to low/ignition, position and press down.

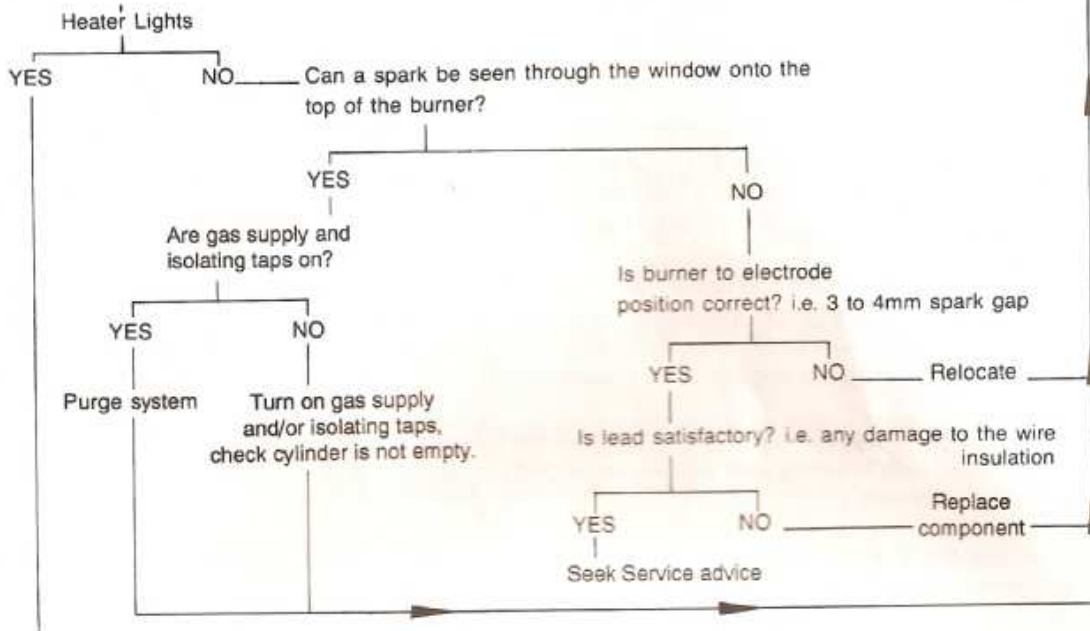

Continue to hold the control knob down for a minimum of thirty seconds. On release of the knob does the flame continue to burn?

